

Specifications:

Sound level Category	Loud Sound Level
Mode of Operation	Continuous tone
Voltage Rating	3 to 7 Vdc
Frequency	2900 Hz ± 500 Hz
Loudness (Min. Voltage)	80 dB(A) min. @ 2 FT and 3 Vdc
Loudness (Max Voltage)	90 dB(A) min. @ 2 FT and 7 Vdc
Current Draw	4 mA Max @ 3 Vdc
Current Draw	12 mA Max @ 7 Vdc
Storage Temperature	-40°C to +85°C
Operating Temperature	-30°C to +65°C
Weight (Typical)	1.6 oz (45 g)
Housing	6/6 Nylon, Color Black
Environmental Approvals	NEMA 3R, 4X & 12; IP-66; CSA C22.2 No. 94; Hazardous Loc. Class I, Div, II, Grps A, B, C & D
Panel Mounting	Recommended hole size is 1.25" (31.75mm). Threaded front will fit standard 30mm (1.181") hole.
Mounting (see note B)	Gasket (included with alarm) must be used to ensure compliance to all Environmental Approvals.
Options	For other options contact factory

Dimensions: Inches (mm)

UL Recognized 

ROHS Compliant

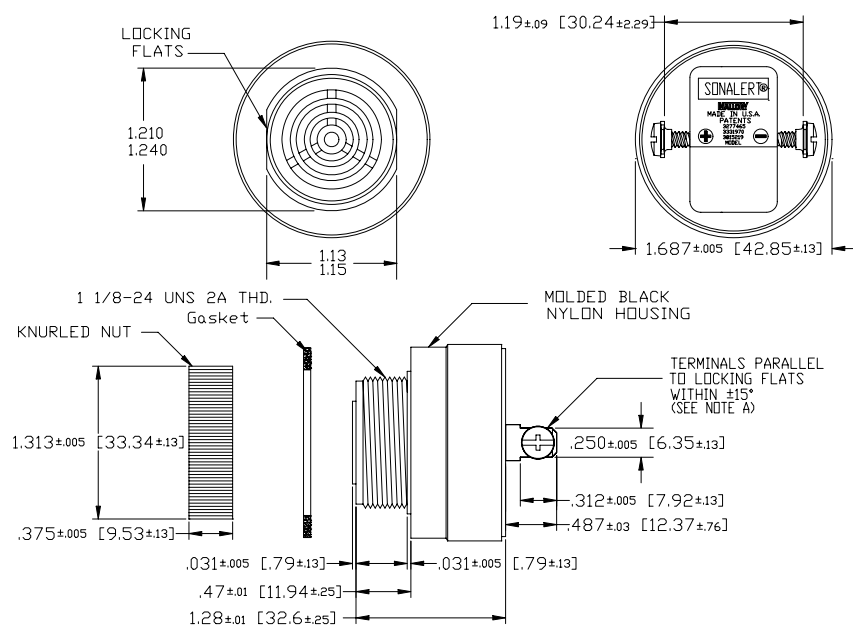

NOTE A: TERMINALS-.032 BRASS TIN PLATED, TAPPED FOR #6-32 SCREW. TWO #6-32 NICKEL PLATED BRASS SCREWS INCLUDED. WILL ACCEPT 1/4" QUICK CONNECT.

NOTE B: MOUNTING- REMOVE BLACK PLASTIC NUT WHILE LEAVING GASKET ON THREADED NECK OF ALARM. INSERT THREADED NECK THROUGH APPROPRIATE SIZED PANEL HOLE. SCREW NUT BACK ONTO THREADED FRONT SECURING ALARM TO PANEL. MAX RECOMMENDED TORQUE IS 10 IN-LBS.